

Chatam 43

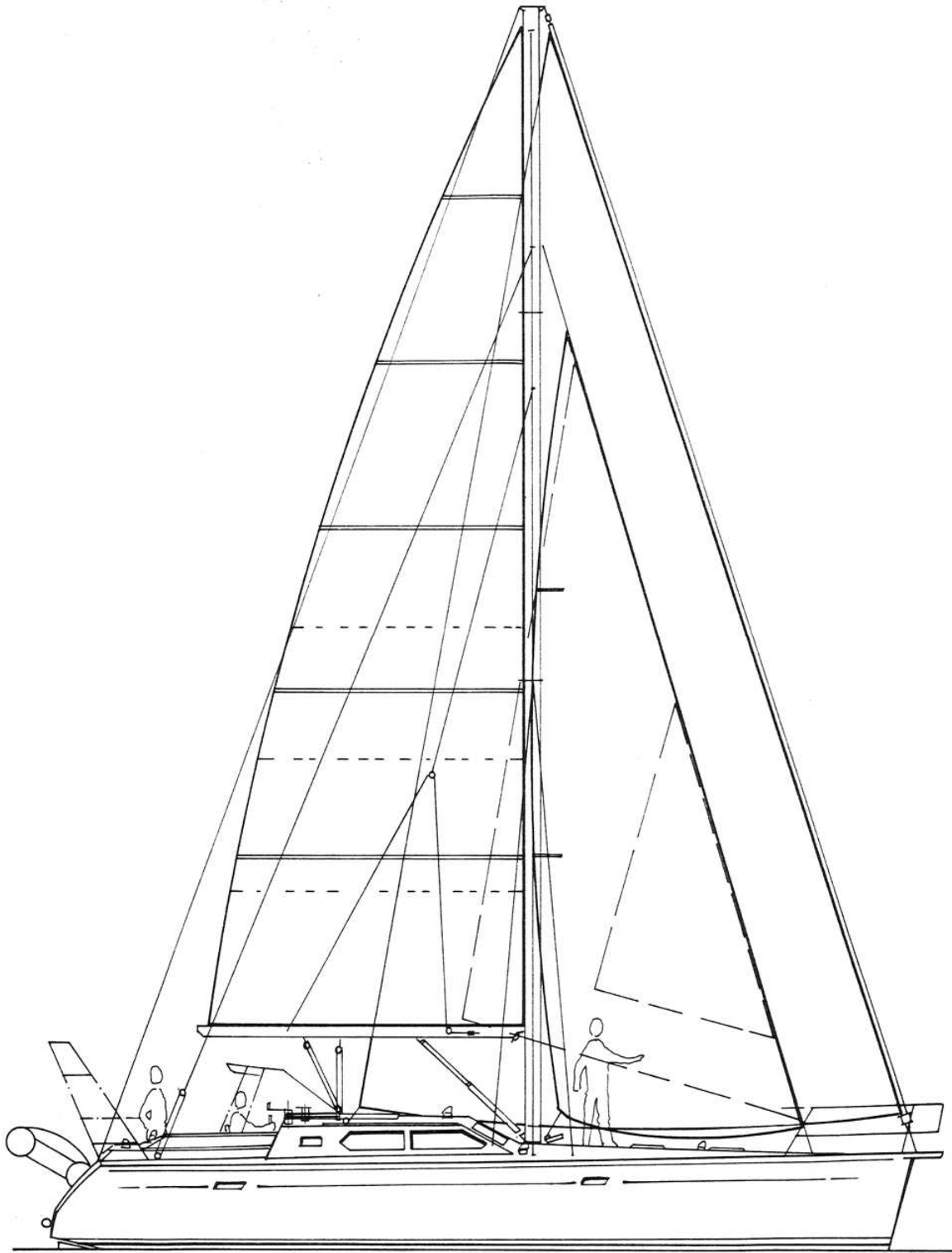

Chatam 43. Cotre.

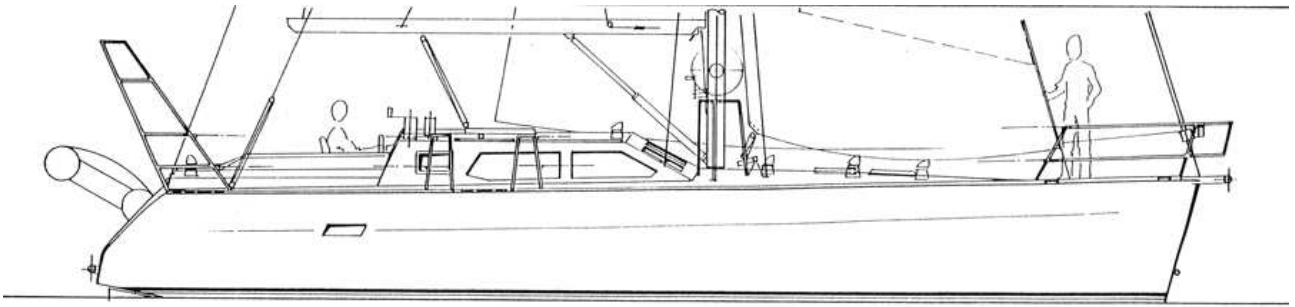

G. CARRE P. DUFRESNE

43'

SILHOUETTE ET DISPOSITION GÉNÉRALE DE PAVÉ
SALON DE PONT - COCKPIT ARRIÈRE - COTRE -

1 m

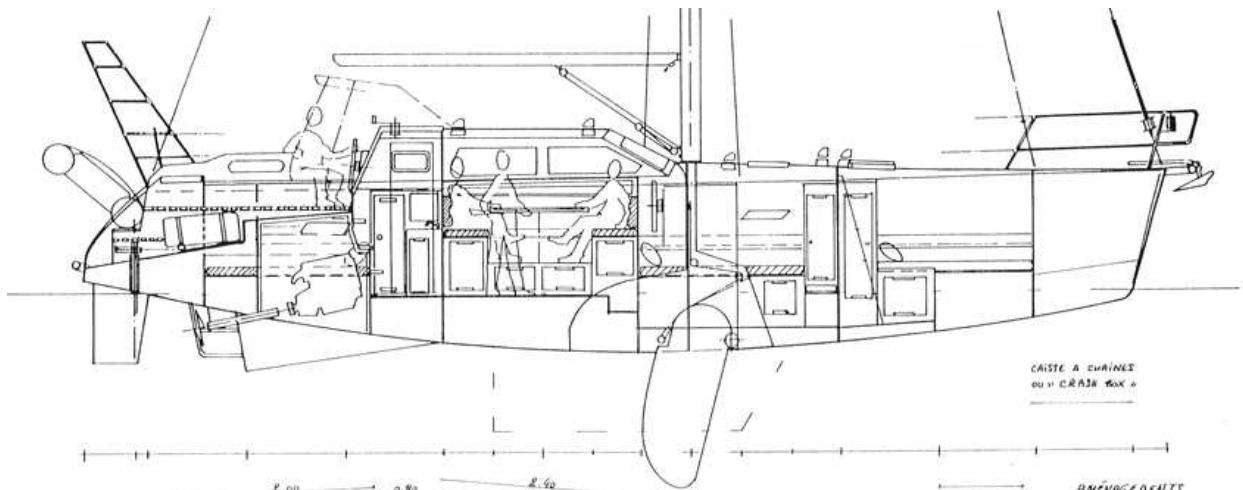
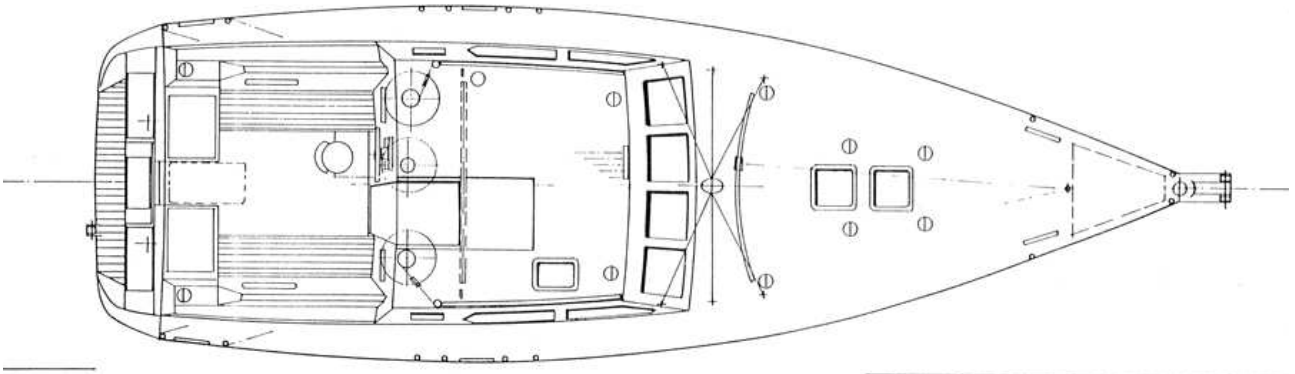

CAISSE À CHAINES
OU "CRASH BOX"

0.50 2.00 0.82 2.60 2.00 1 m

AMÉNAGEMENTS
SALON DE PONT

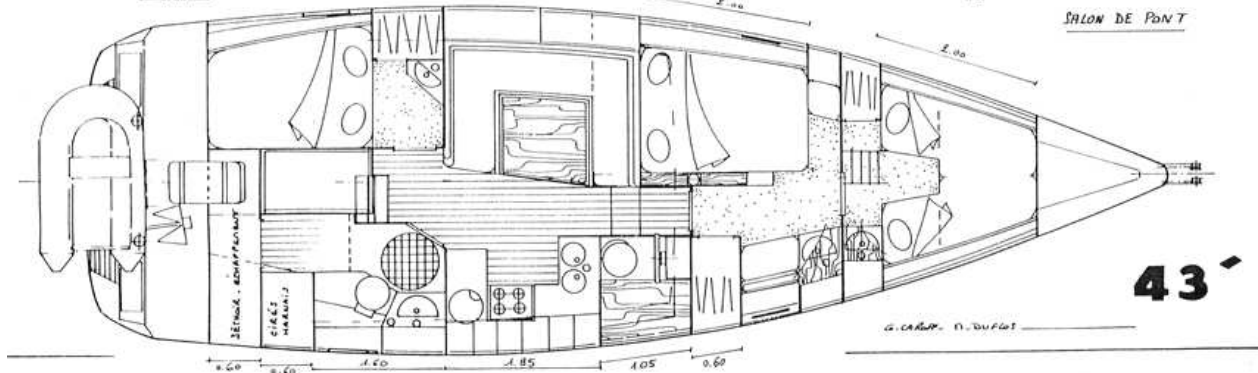

0.60 0.60 1.40 1.85 1.05 0.60

G. CARRE P. DUFRESNE

43'

Chatam 43, DI, cotre, à salon de pont.

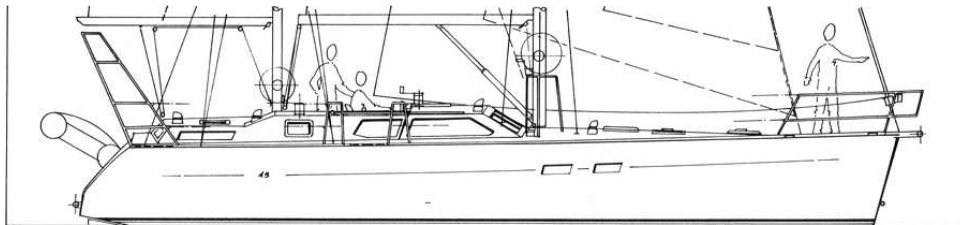

R.E. G. CARBÉ P. DUPUIS **43'** SILHOUETTE ET DISPOSITION GÉNÉRALE DE PONT KETCH (ou cotre) A COCKPIT CENTRAL

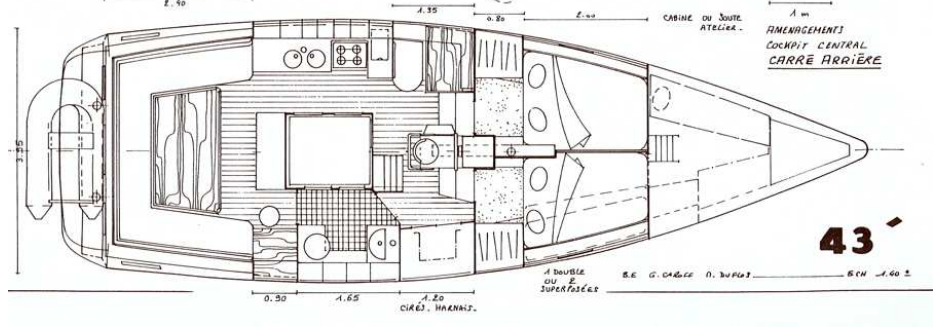
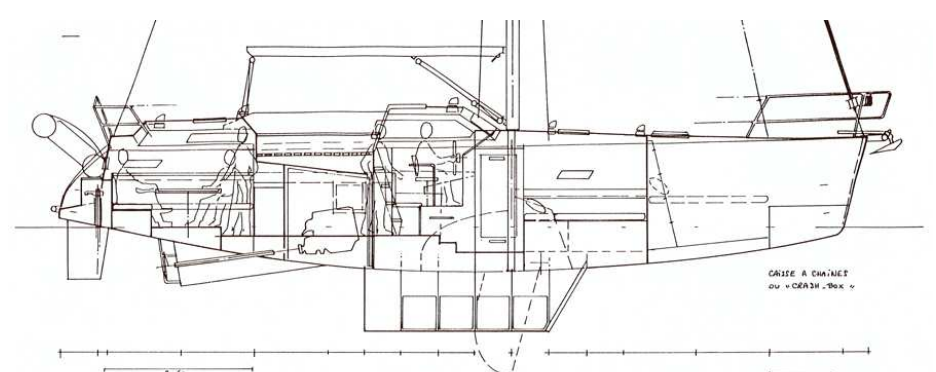
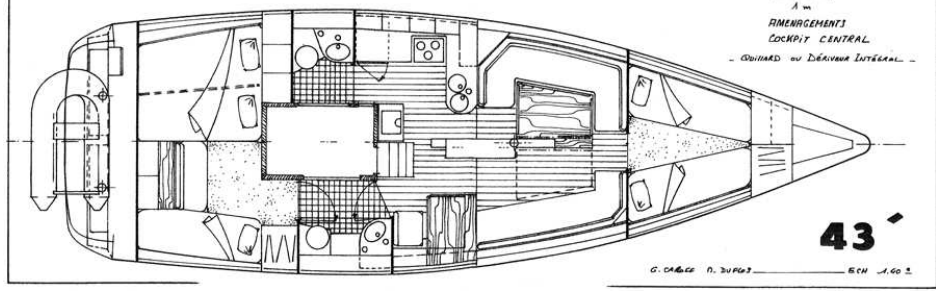
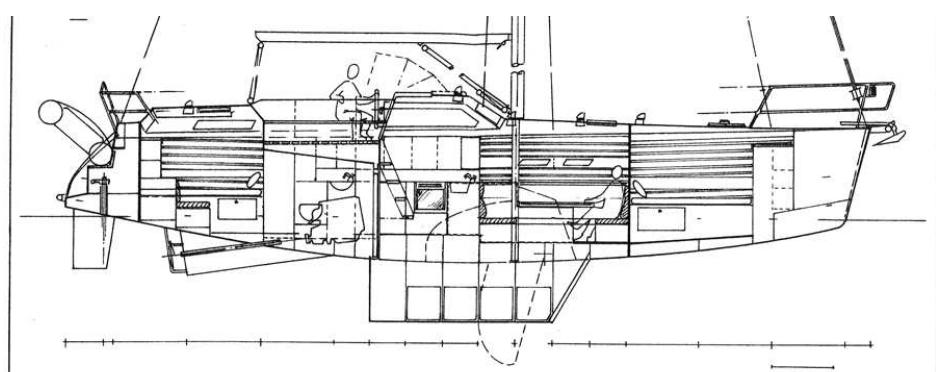
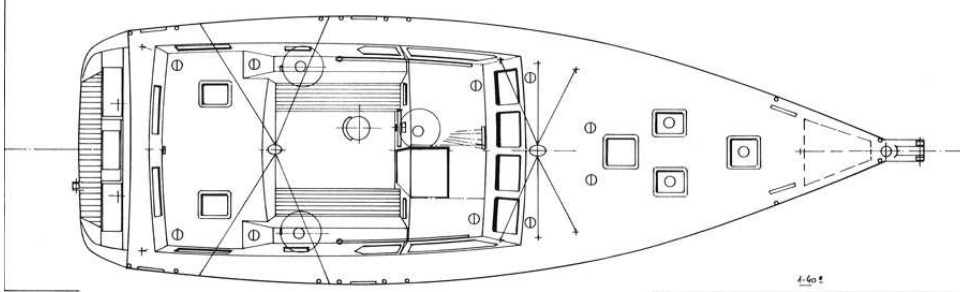

Quillard ou DI, cockpit central. Cabine arrière ou carré arrière. Cotre ou ketch.

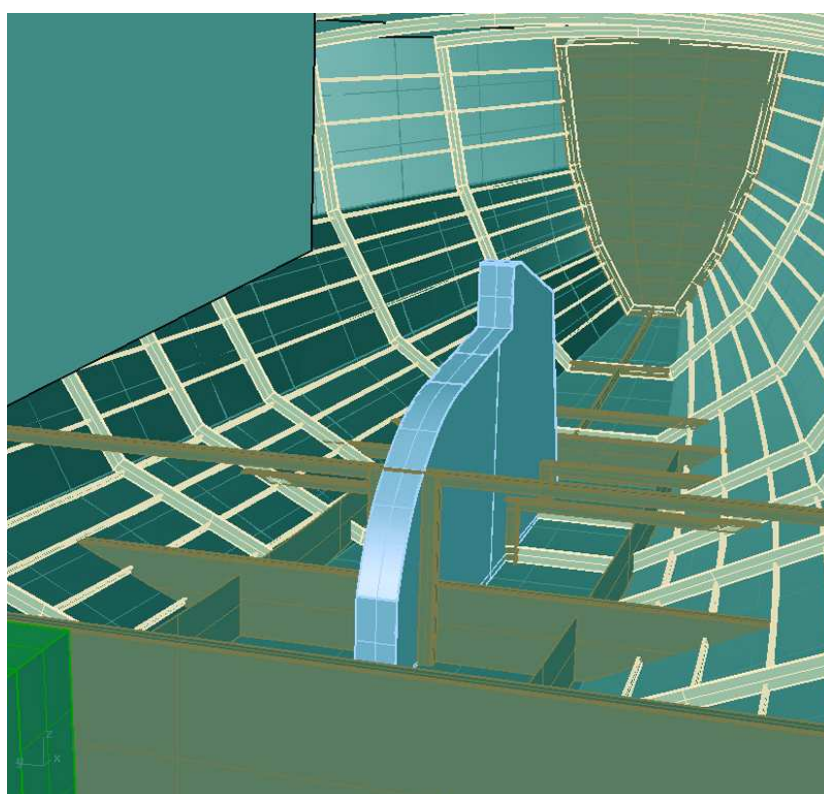
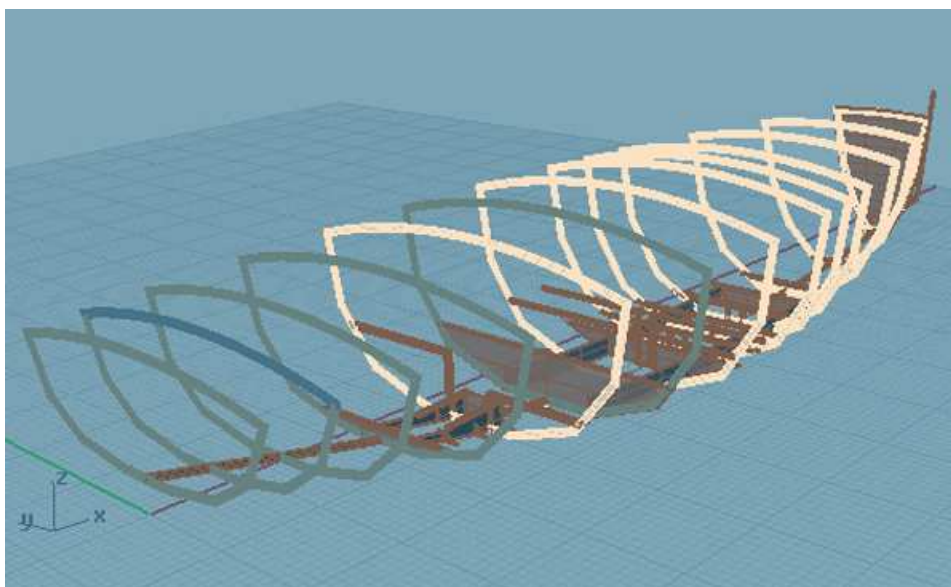
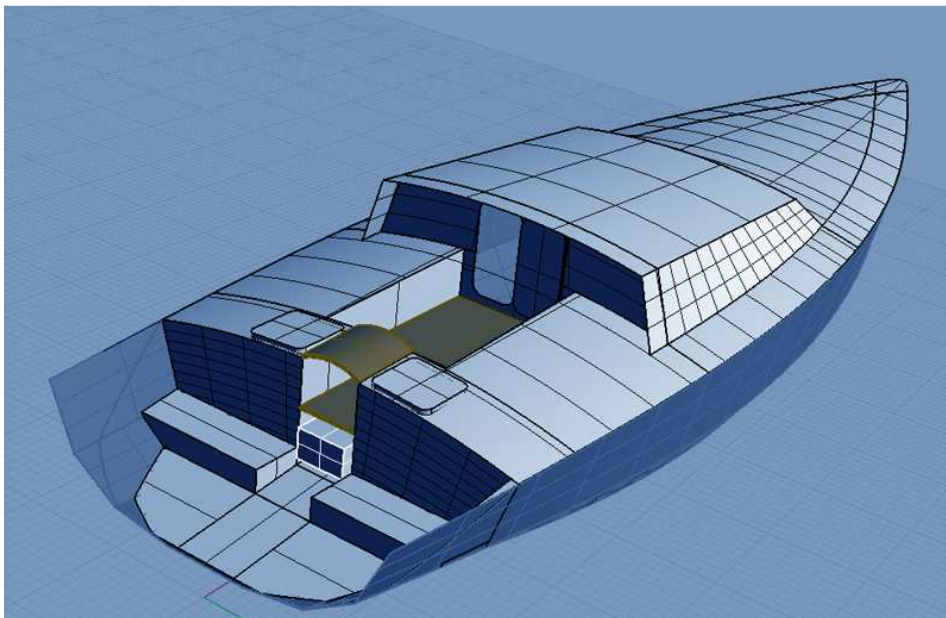

Chatam 43. DI. Salon de pont. Numérisation André Langevin. Québec.